

PRODUCENT PROFILI I GRANULATÓW PVC

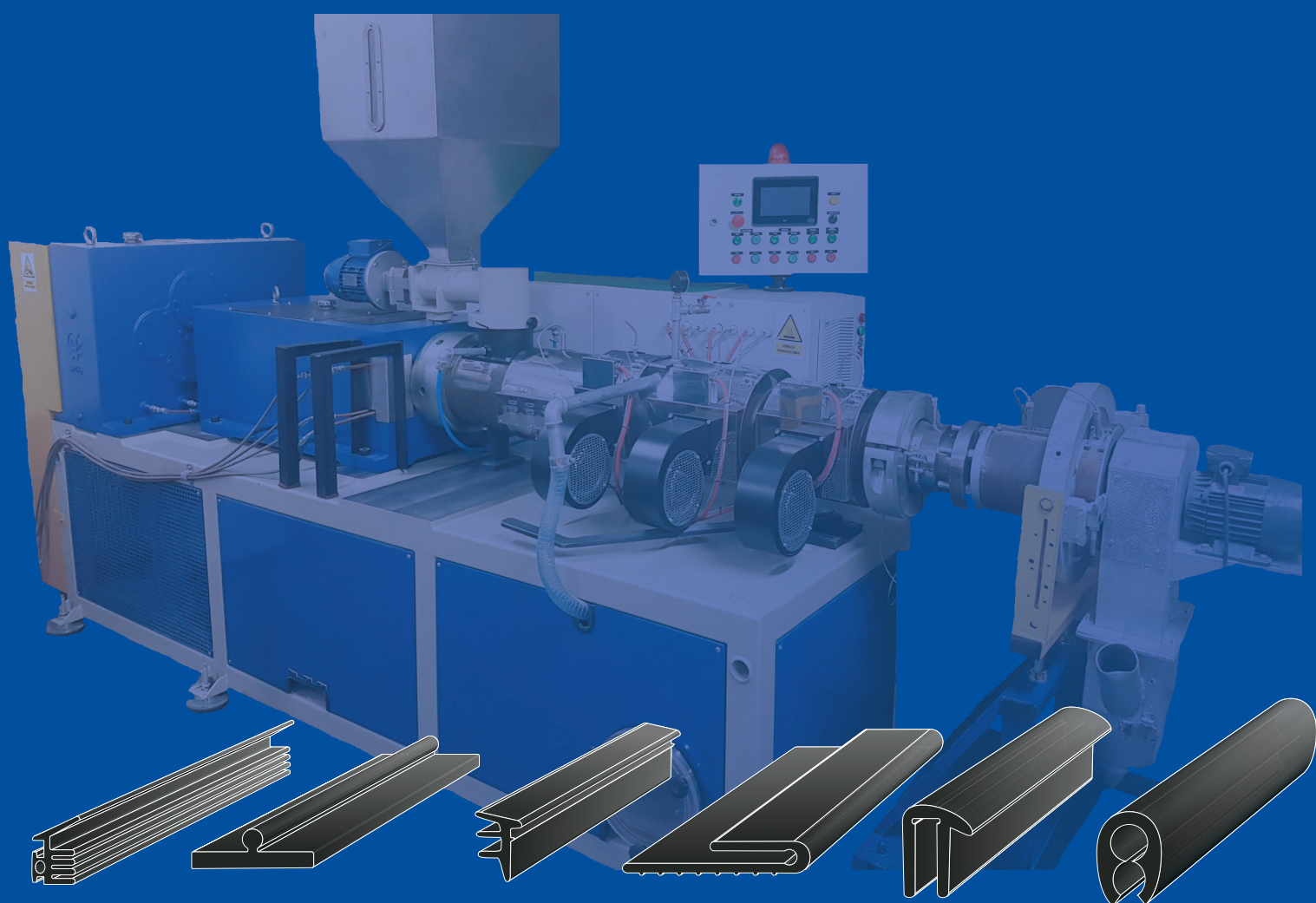

**FIRMA
SKOWROŃSKI**



KATALOG WYROBÓW



“Firma Skowroński Spółka Jawna” to polska firma rodzinna, istniejąca od 1985 roku. Obecnie siedziba firmy mieści się w województwie kujawsko - pomorskim (Młyniec Pierwszy k. Torunia).

“Firma Skowroński Sp.J.” to firma z branży przetwórstwa tworzyw sztucznych. Nasze produkty docierają do wielu branż, m.in.: budowlanej, reklamowej, motoryzacyjnej, skutniczej, rolniczej i wielu innych. Obecnie spółka posiada w swojej ofercie handlowej kilkadziesiąt wyrobów w kilkunastu kolorach, które prezentujemy w najnowszym katalogu.

Nieustannie rozszerzamy swoją ofertę o nowe produkty i usługi. Codziennie udowadniamy, że produkt dobrej jakości nie musi być drogi. Nasze atuty to indywidualne podejście do klienta oraz krótki czas realizacji zamówień, trwałość produktów, możliwość szybkiego przezbrojenia i produkcja nawet nietypowych zleceń.

Prowadzimy sprzedaż swoich produktów zarówno stacjonarnie, jak i przez internet - posiadamy swój sklep internetowy oraz stronę www. Nasze produkty są obecnie dostarczane głównie na rynek Polski, ale również na rynki zagraniczne.

Nasza firma cały czas się rozwija. Inwestujemy w nowoczesne maszyny i urządzenia. W 2017 roku przenieśliśmy produkcję na nową halę, zwiększając tym samym nasze możliwości produkcyjne.

Zapraszamy do kontaktu !

OKŁADZINA PORĘCZOWA

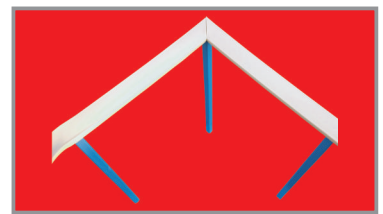
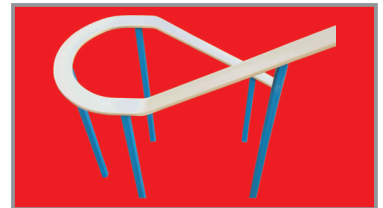
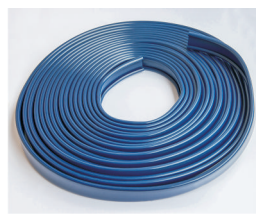
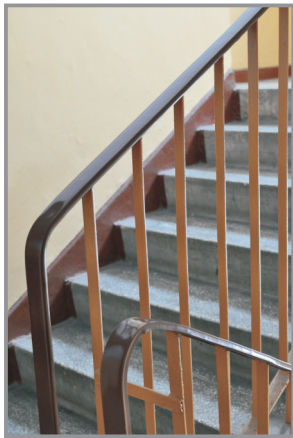

Wymiar [mm] (nr produktu)	Produkt (rysunek)	Produkt (rysunek 3D)	Kolor
40 x 6 (401) 40 x 8 (402)			czarny szary jasny szary ciemny niebieski brązowy zielony czerwony sosna granatowy srebrny złoty biały
30 x 8 (405)			
35 x 6 (401/1) 35 x 8 (402/1)			
50(45) x 8 (403)			



Okładzina poręczowa produkowana jest w krążkach po 20 mb.

Nasze wyroby posiadają atesty PZH w Warszawie: HK/B/1007/01/2012, HK/B/1198/01/2014, HK/B/1286/01/2014.
 Na życzenie dostarczamy wzorniki wszystkich wyrobów. Istnieje możliwość wykonania w innych odcinkach i kolorach po uprzednim uzgodnieniu ceny, oraz terminu wykonania.
 Pełna oferta na: www.firmaskowronski.pl oraz www.sklep.firmaskowronski.pl

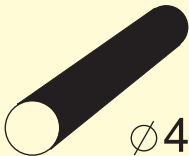
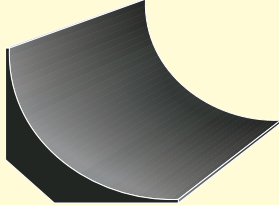
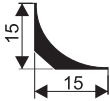
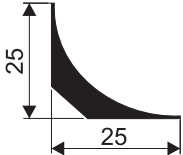
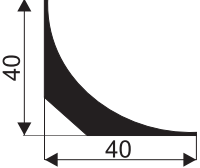
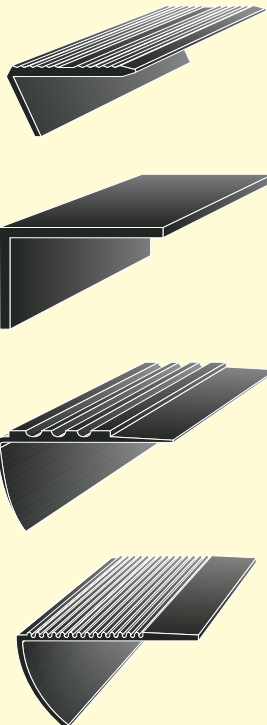
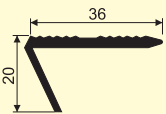
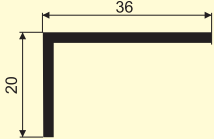
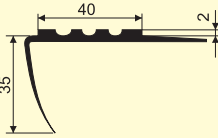
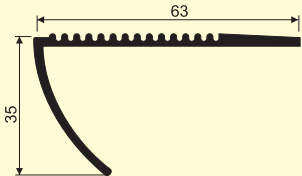
PROFILE WYKOŃCZENIOWE

Nazwa Produktu	Wymiar [mm] (nr produktu)	Produkt	Pakowanie	Kolor
Sznur Spawalniczy 	$\varnothing 4$ (801)		szpula 2 kg ok. 130 mb	czarny brązowy szary biały
Wyobleniowe 	15 x 15 (302)		2,5 mb x 40 szt.	czarny
	25 x 25 (301)		2,5 mb x 20 szt.	czarny
	40 x 40 (303)		do ustalenia *	czarny
Noski Schodowe 	36 x 20 (101)		2,5 mb x 10 szt.	czarny szary brązowy
	36 x 20 (104)		2,5 mb x 10 szt.	czarny szary brązowy
	40 x 35 (102)		1,5 mb x 10 szt. 2 mb x 10 szt. 2,5 mb x 10 szt.	czarny szary brązowy
	63 x 35 (103)		2,5 mb x 10 szt.	czarny szary brązowy

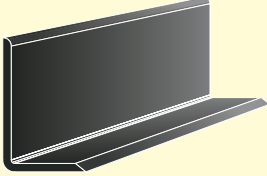
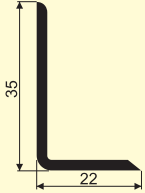
PROFILE WYKOŃCZENIOWE

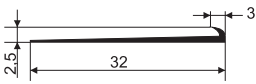
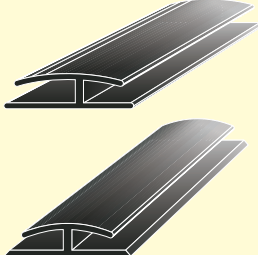
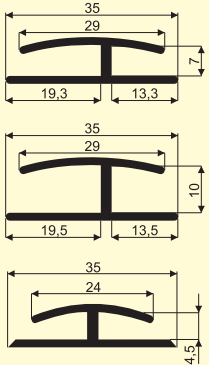
Nazwa Produktu	Wymiar [mm] (nr produktu)	Produkt	Pakowanie	Kolor
Listwa Przypodłogowa 	35 x 22 (501) ryflowana (502) gładka		krążki 20 mb x 5 szt.	20 kolorów w/g wzornika
Wykończeniowa 	32 x 2,5 (601)		2,5 mb x 20 szt.	biały czarny szary brązowy
Listwy Progowe 	29 x 7 (202) 29 x 10 (203) 24 x 4,5 (201)		2,5 mb x 20 szt.	biały czarny szary brązowy

PROFILE OKRĄGŁE

Nazwa Produktu	Wymiar [mm]	Produkt	Pakowanie	Kolor
Profil Okrągły 	$\phi 1,5 \div \phi 12^*$		do ustalenia	na zamówienie

**) Istnieje możliwość wykonania innych wymiarów.*



Wykonane w twardościach ok. 70°ShA i ok. 80°ShA. Istnieje możliwość wykonania w innych twardościach.

USZCZELKI DO BRAM GARAŻOWYCH

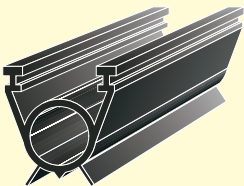
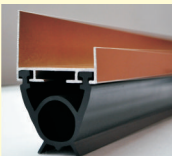
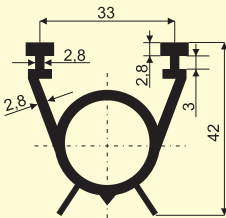
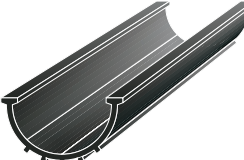
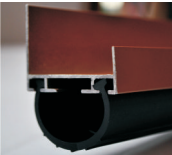
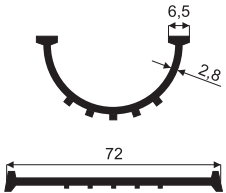
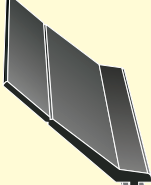
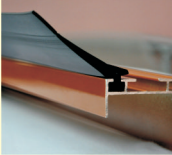
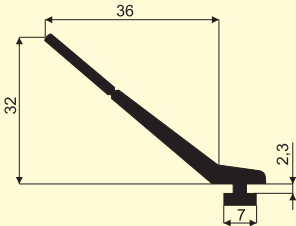
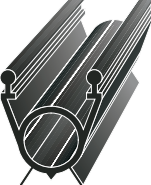
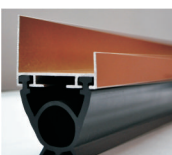
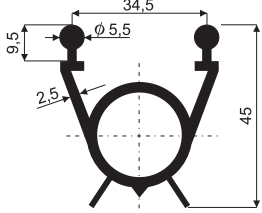
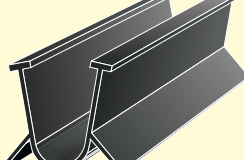
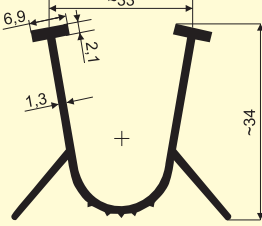
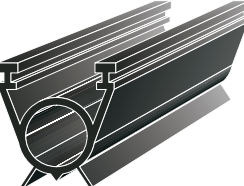
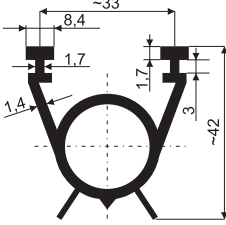
PVC MODYFIKOWANE ELASTOMEREM

Nazwa Produktu (nr produktu)	Zastosowanie	Produkt	Pakowanie	Kolor
Dolna UB1 (1401) 			do ustalenia	czarny
Dolna UB2 (1402) 			do ustalenia	czarny
Górna UB3 (1403) 			do ustalenia	czarny
Dolna UB4 (1404) 			do ustalenia	czarny
Górna UB5 (1405) 			do ustalenia	czarny
Dolna UB6 (1406) 			do ustalenia	czarny

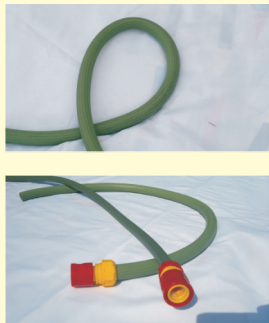
WĘŻE OGRODOWE





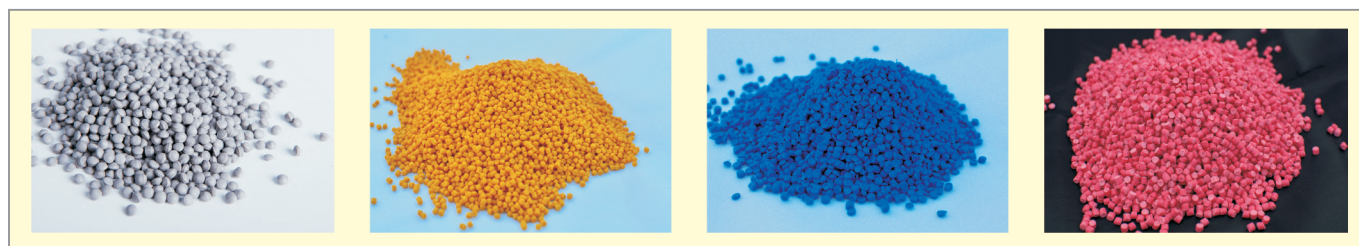



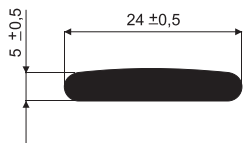

Nazwa Produktu	Wymiar	Produkt	Pakowanie	Kolor
<p>Wąż Ogrodowy</p>    	<p>1/2 cala</p> <p>3/4 cala</p>	<p>Specjalnie dobrana mieszanka PVC oraz znacznie grubsza ścianka od węży powszechnie dostępnych na rynku pozwoliła na uzyskanie dużej sprężystości oraz wytrzymałości węża. Dzięki temu jest on odporny na zginanie oraz skręcanie.</p>	<p>20 mb</p> <p>30 mb</p> <p>50 mb</p>	<p>zielony pomarańczowy</p>

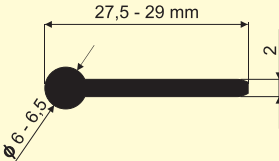
GRANULATY

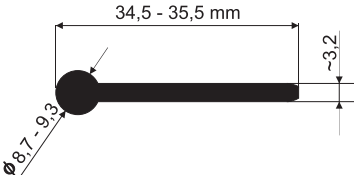
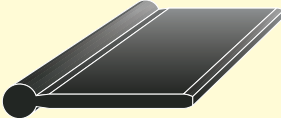
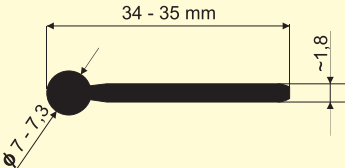

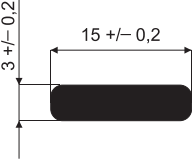
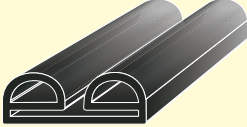
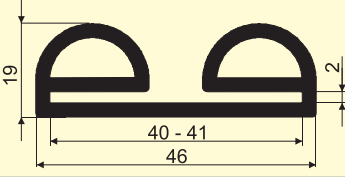

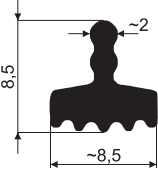

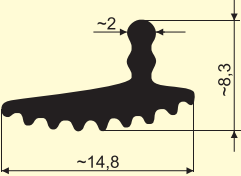



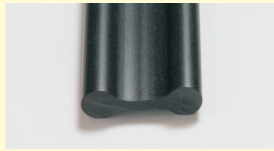
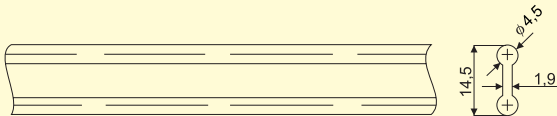

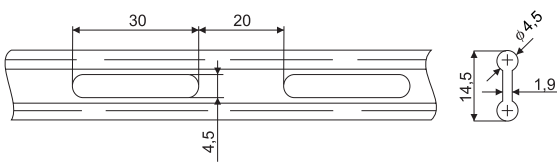
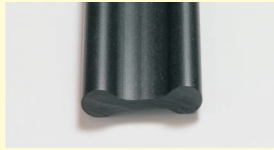
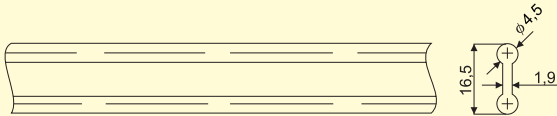
Produkujemy **granulaty PVC** do różnych zastosowań. Granulaty wytwarzane są z suspensyjnego polichlorku winylu (PVC) oraz odpowiednich plastyfikatorów z dodatkiem środków pomocniczych, takich jak stabilizatory, smary, pigmenty. Recepturę przygotowujemy specjalnie na życzenie klienta osiągając oczekiwane parametry techniczne w zakresie twardości 40 - 90 Sh(A).

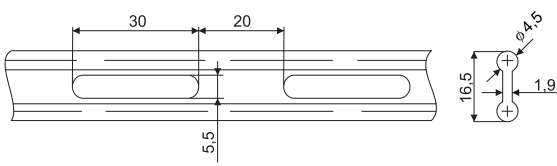

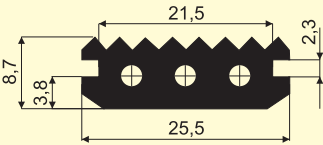

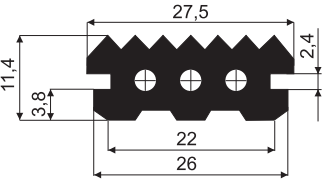

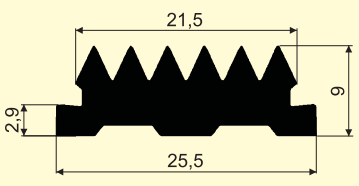
PROFILE INNE

Nazwa Produktu	Wymiar [mm] (nr produktu)	Produkt	Pakowanie	Kolor
Saneczkowy 	24 x 5,5 (1004)		do ustalenia	na zamówienie
Kedra 	w/g ustaleń		szpula 130 mb	na zamówienie
Kedra (1704) 	w/g ustaleń		szpula 130 mb	na zamówienie
Kedra (1705) 	w/g ustaleń		szpula 130 mb	na zamówienie
Prostokątny 	15 x 3 (1005)		szpula od 150 do 300 mb	na zamówienie
Uszczelka obciążnika 	46 x 19 (1506)		szpula 25 mb	na zamówienie
Sznur T1 	(1701)		szpula 200 mb	na zamówienie
Sznur T2 	(1702)		szpula 200 mb	na zamówienie

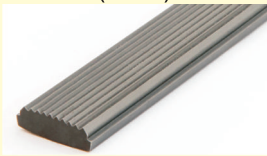
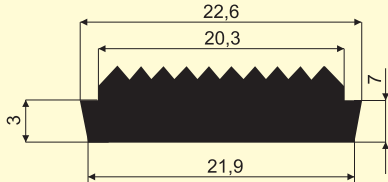

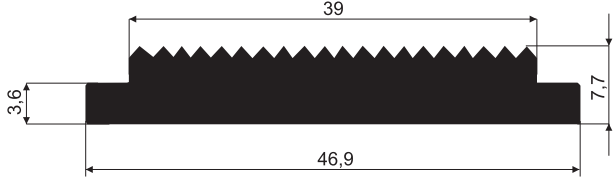

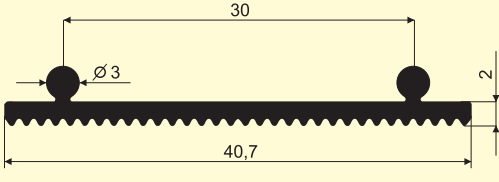
PROFILE DO WYCIERACZEK SYSTEMOWYCH

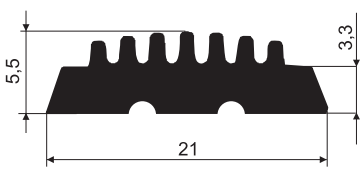
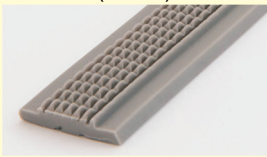
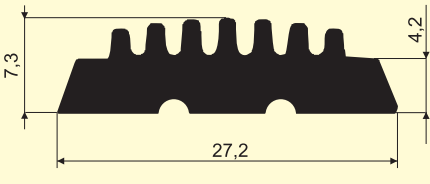
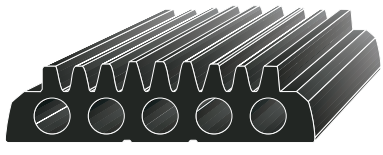
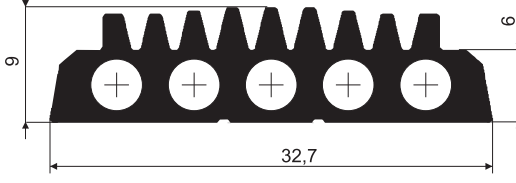
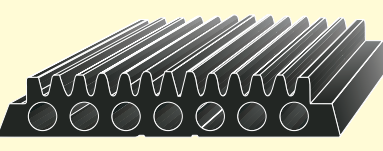
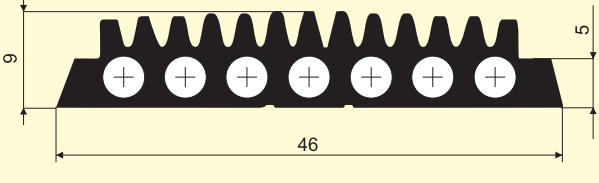
Nazwa Produktu (nr produktu)	Produkt	Kolory
<p>Łącznik bezotworowy 14,5 mm (1006)</p> 		czarny
<p>Łącznik otworowy 14,5 mm (1006p)</p> 		czarny
<p>Łącznik bezotworowy 16,5 mm (1007)</p> 		czarny
<p>Łącznik otworowy 16,5 mm (1007p)</p> 		czarny
<p>Wkład czyszczący winylowy (1008)</p> 		szary czarny brązowy
<p>Wkład czyszczący winylowy (1009)</p> 		szary czarny brązowy
<p>Wkład czyszczący winylowy (1010)</p> 		szary czarny brązowy



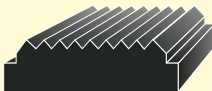
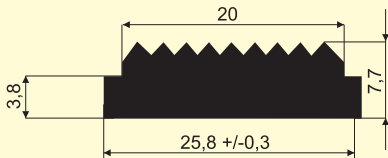
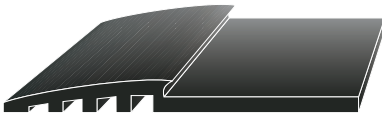
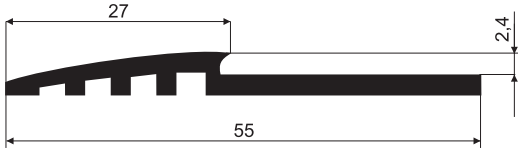
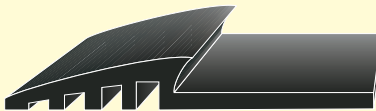
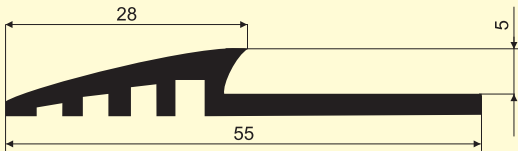

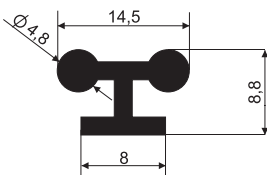
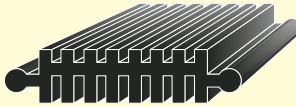
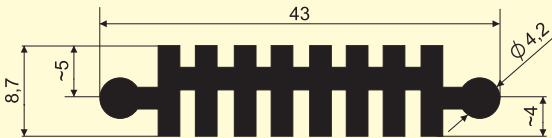
PROFILE DO WYCIERACZEK SYSTEMOWYCH

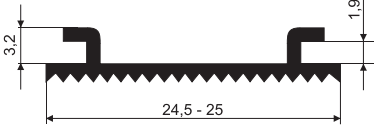
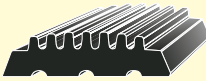
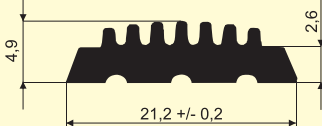
Nazwa Produktu (nr produktu)	Produkt	Kolory
<p>Wkład czyszczący winylowy (1011)</p> 		szary czarny brązowy
<p>Wkład czyszczący winylowy (1012)</p> 		szary czarny brązowy
<p>Podkład tłumiący winylowy (1013)</p> 		szary czarny brązowy
<p>Wkład czyszczący winylowy (1015)</p> 		szary czarny brązowy
<p>Wkład czyszczący winylowy (1016)</p> 		szary czarny brązowy
<p>Wkład czyszczący winylowy (1017)</p> 		szary czarny brązowy
<p>Wkład czyszczący winylowy (1018)</p> 		szary czarny brązowy

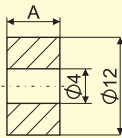

PROFILE DO WYCIERACZEK SYSTEMOWYCH

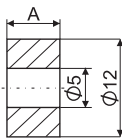
Nazwa Produktu (nr produktu)	Produkt	Kolory
<p>Wkład czyszczący winylowy (1019)</p> 		szary czarny brązowy
<p>Profil wykończeniowy do mat tekstylnych 2 mm (1020)</p> 		szary czarny brązowy
<p>Profil wykończeniowy do mat tekstylnych 5 mm (1021)</p> 		szary czarny brązowy
<p>Łącznik z podstawą (1022)</p> 		szary czarny brązowy
<p>Profil zakończeniowy "grzebień" (1023)</p> 		szary czarny brązowy
<p>Podkład tłumiący winylowy (1024)</p> 		szary czarny brązowy
<p>Wkład czyszczący winylowy (1025)</p> 		szary czarny brązowy

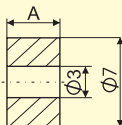
TULEJKI DYSTANSOWE DO WYCIERACZEK SYSTEMOWYCH

Nazwa Produktu (nr produktu)	Produkt	Kolory
<p>Tulejka dystansowa ($\Phi 12 / \Phi 4$ mm)</p> 	<p>wymiar A do ustalenia</p> 	czarny szary
<p>Tulejka dystansowa ($\Phi 12 / \Phi 5$ mm)</p> 	<p>wymiar A do ustalenia</p> 	czarny szary
<p>Tulejka dystansowa ($\Phi 7 / \Phi 3$ mm)</p> 	<p>wymiar A do ustalenia</p> 	czarny szary

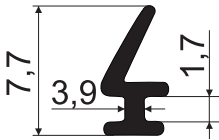
PROFILE DO ŻALUZJI

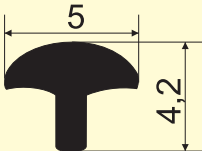
Nazwa Produktu	Nr produktu	Produkt	Pakowanie	Kolor
<p>Uszczelka</p> 	(1003)		do ustalenia	na zamówienie
<p>Klin</p> 	(1002)		do ustalenia	na zamówienie

LISTWA MEBLOWA

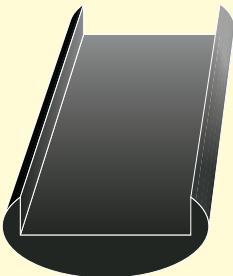
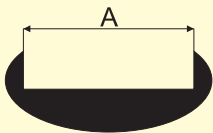
Nazwa Produktu	Wymiar [mm] (nr produktu)	Produkt	Pakowanie	Kolor
Listwa meblowa 	7 (1102)		do ustalenia	na zamówienie
	8 (1105)			
	9 (1105/1)			
	10 (1104/1)			
	12 (1104)			
	14 (1101/2)			
	15 (1101/1)			
	16 (1101)			
	18 (1103)			

PROFILE DO STANDÓW REKLAMOWYCH

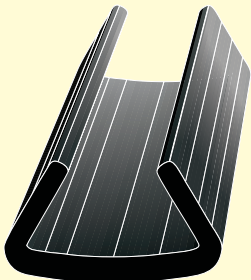
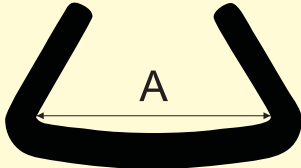
Nazwa Produktu	Wymiar [mm] (nr produktu)	Produkt	Pakowanie	Kolor
Profil do standów 	7 (1601)		Do ustalenia	Na zamówienie
	8 (1602)			
	9 (1602/1)			
	10 (1603)			
	12 (1604)			
	14 (1605)			
	15 (1605/1)			
	16 (1606)			
	18 (1606/1)			

WKŁADKI TŁUMIĄCE DO OBEJM NA RURY







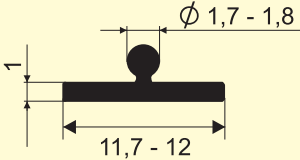

Rysunek	Symbol (nr produktu)
	WT 20x1,5 (901)
	WT 25x2,5/B (902)
	WT 30x3 (903)
	WT 25x1 (904)
	WT 20x2/A (905)
	WT 25x3 (906)
	WT 25x3W (907)
	WT 25x2W (912)
	WT 20x2/B (908)
	WT 20x2 (909)

Rysunek	Symbol (nr produktu)
	WT 20x1,5/B (910)
	WT 20x1,5/C (911)
	WT 24x1,5 (913)
	WT 25x2 (914)
	WT 25x2,5/A (915)
	WT 20x1,5/A (916)
	WT 26x2W (917)
	WT 35x3 (918)
	WT 50x6 (919)

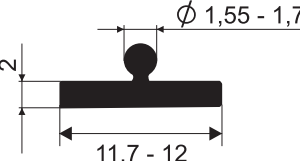
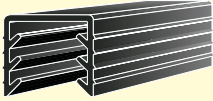
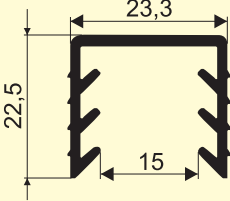
Wykonane w kolorze czarnym, istnieje możliwość wykonania produktu w innym kolorze oraz innych wymiarach.

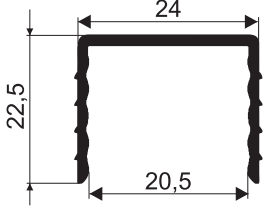
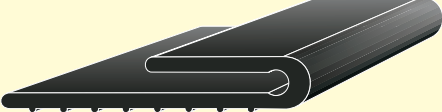
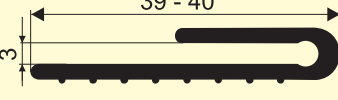
PROFILE DO SYSTEMÓW BALUSTRAD

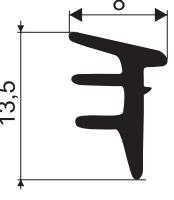
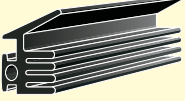
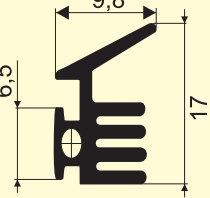
Nazwa Produktu (nr produktu)	Produkt (rysunek)	Pakowanie	Kolor
Uszczelka 12 x 1 (1501) 		do uzgodnienia	czarny
Uszczelka 12 x 2 (1502) 		do uzgodnienia	czarny
Uszczelka L 17 (1503) 		do uzgodnienia	czarny
Uszczelka L 21 (1504) 		do uzgodnienia	czarny
Uszczelka do przewodnic (1505) 		do uzgodnienia	czarny
Uszczelka przyszybowa M5 (1507) 		do uzgodnienia	czarny
Uszczelka przyszybowa P5 (1509) 		do uzgodnienia	czarny

PROFILE DO SYSTEMÓW BALUSTRAD

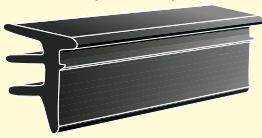
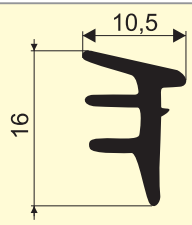
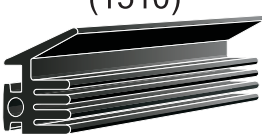
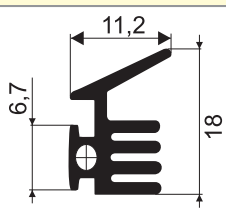
Nazwa Produktu (nr produktu)	Produkt (rysunek)	Pakowanie	Kolor
Uszczelka przyszybowa M7 (1508) 		do uzgodnienia	czarny
Uszczelka przyszybowa P7 (1510) 		do uzgodnienia	czarny

PROFILE DO STOJAKÓW TRANSPORTOWYCH

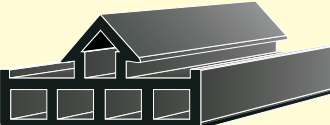
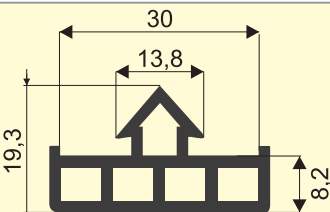
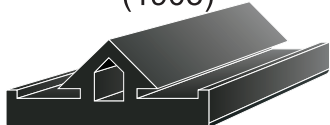
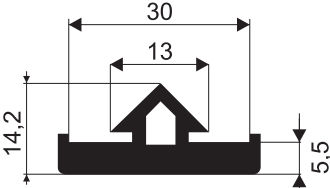
Nazwa Produktu (nr produktu)	Produkt (rysunek)	Pakowanie	Kolor
Profil komorowy (1902) 		do uzgodnienia	czarny szary biały transparentny
Profil pełny (1903) 		do uzgodnienia	czarny szary biały

PROFILE DO SZYN WENTYLACYJNYCH

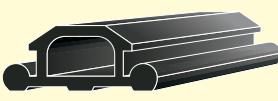
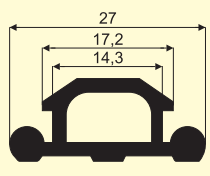
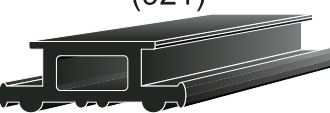
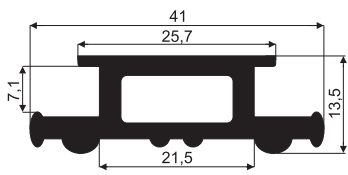
Nazwa Produktu (nr produktu)	Produkt (rysunek)	Pakowanie	Kolor
STRUT 28 x 12 (920) 		do uzgodnienia	czarny
STRUT 40 x 12,5 (921) 		do uzgodnienia	czarny

PROFILE ODBOJOWE

Nazwa Produktu	Nr produktu	Produkt (rysunek)	Pakowanie	Kolor
Profil obojowy 	1801		do uzgodnienia	czarny szary biały
Profil obojowy 	1802		do uzgodnienia	czarny szary biały
Profil obojowy 	1803		do uzgodnienia	czarny szary biały
Profil obojowy 	1804		do uzgodnienia	czarny szary biały
Profil obojowy 	1805		do uzgodnienia	czarny szary biały





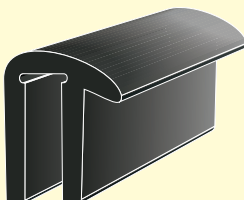
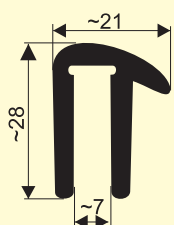
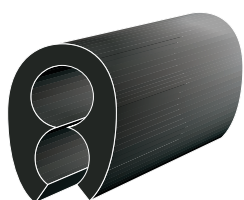
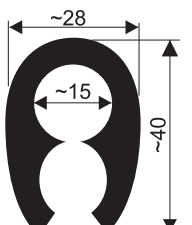

Istnieje możliwość wykonania innych kolorów.

PROFILE ODBOJOWE

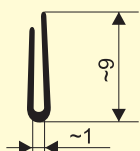
Nazwa Produktu	Nr produktu	Produkt (rysunek)	Pakowanie	Kolor
Profil odbojowy 	1806		do uzgodnienia	czarny szary biały
Profil odbojowy 	1807		do uzgodnienia	czarny szary biały

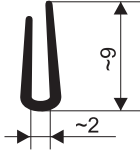
Istnieje możliwość wykonania innych kolorów.

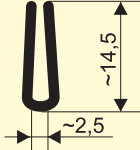
USZCZELKI KRAWĘDZIOWE

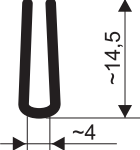
Nazwa Produktu	Nr produktu	Produkt (rysunek)	Pakowanie	Kolor
Uszczelka krawędziowa 1 mm 	1706		do uzgodnienia	czarny biały
Uszczelka krawędziowa 2 mm 	1707		do uzgodnienia	czarny biały
Uszczelka krawędziowa 2,5 mm 	1708		do uzgodnienia	czarny biały
Uszczelka krawędziowa 4 mm 	1709		do uzgodnienia	czarny biały

Istnieje możliwość wykonania innych kolorów.

SZTACHETY PVC

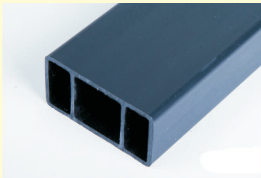
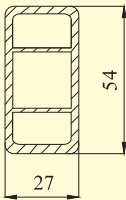

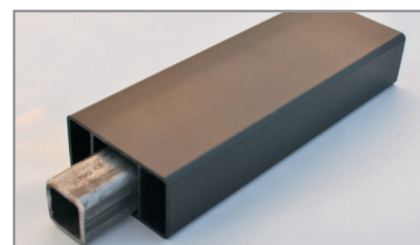
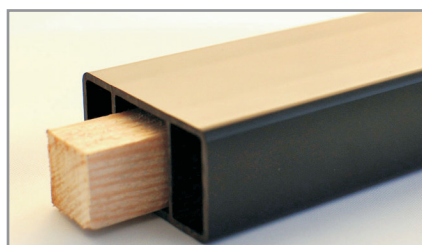
Nazwa Produktu	Wymiar [mm]	Produkt (rysunek)	Pakowanie	Kolor
Sztacheta 	54 x 27		cięcie na wymiar	brązowy czarny



PRZYKŁADY ZASTOSOWANIA

Płotki ogrodowe i Pergole	Kratki i podesty	Płoty, Bramy i Furtki	Ławki i Ławeczki
			
			
			

WĘŻE DO POWLEKANIA TRZONKÓW ŁOPAT, SZPADLI itp.

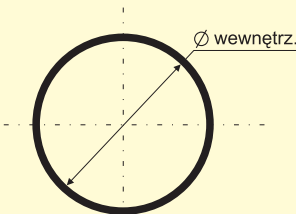
Nazwa Produktu	Wymiar	Produkt	Pakowanie	Kolor
<p>Wąż do Powlekania</p>   	<p>Ø 31 x 1,35</p> <p>Ø 29 x 1,35</p> <p>Ø 26,5 x 1</p> <p>Ø 24 x 0,8*</p>		<p>cięte na odcinki lub zwinęte w kręgi</p>	<p>czarny*</p>

Wąż PVC do powlekania m.in. łopat, szpadli, łopat do śniegu, wioseł i.t.p.

**) Istnieje możliwość wykonania węży o innych wymiarach i w innych kolorach.*



FIRMA SKOWROŃSKI Spółka Jawna

87-162 LUBICZ, MŁYNIEC PIERWSZY

ul. Rzemieśnicza 1

tel. +48 56 674 26 21, kom. +48 694 253 267

biuro@firmaskowronski.com.pl

www.firmaskowronski.com.pl

www.sklep.firmaskowronski.pl

NIP: 879-267-11-15